

Regal VICTOR

Art. 8702

Stückliste:

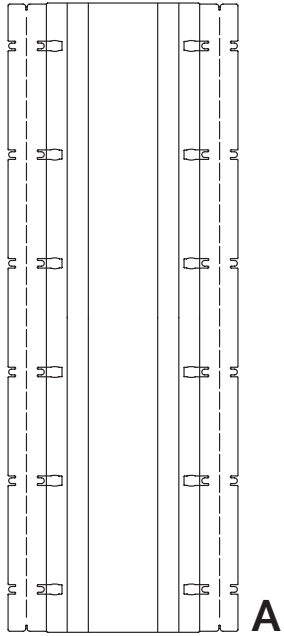

2 Seitenwände



2 Aufbauhilfen

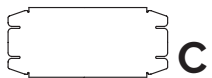

6 x Regalböden

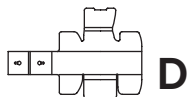

2 Wandhalterungen



2 Schraubensätze



Innen- und Außenseite

Bitte achten Sie beim Aufbau auf die Innen- und Außenseite. Die Innenseite hat immer einzelne, starke Rill-Linien, die Außenseite zwei schwächere.

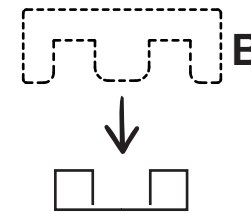
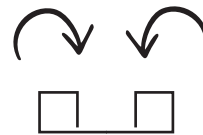
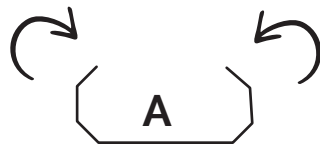
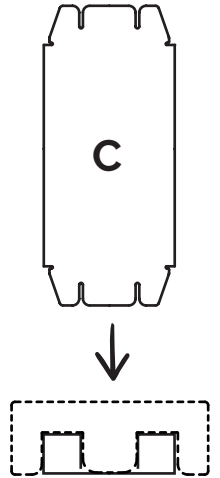
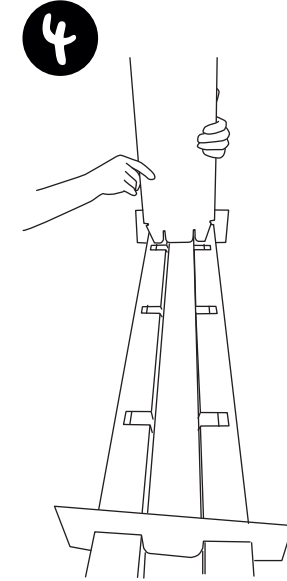
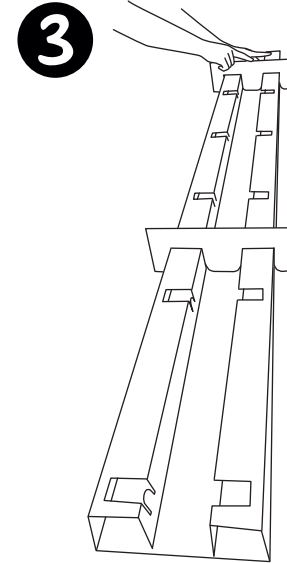
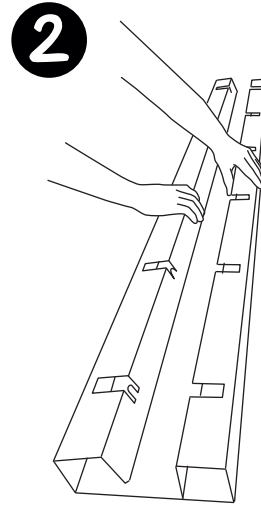
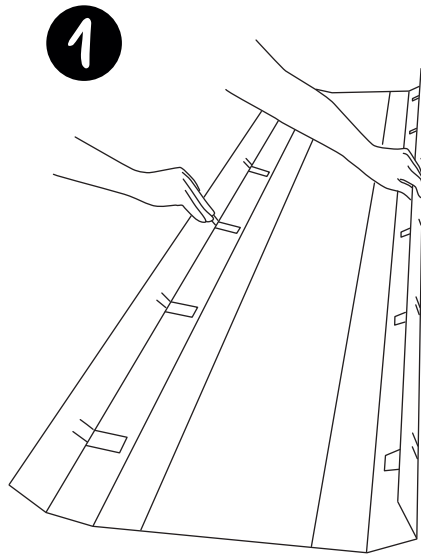

Die Aufbauhilfen **B** dienen dazu, die Seiten zusammenzuhalten - sie können nach dem Aufbau wieder entfernt werden.

VIDEO!

Ein Video zum Aufbau finden Sie auf YouTube:



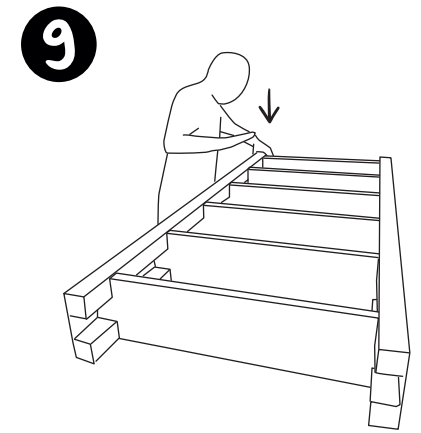
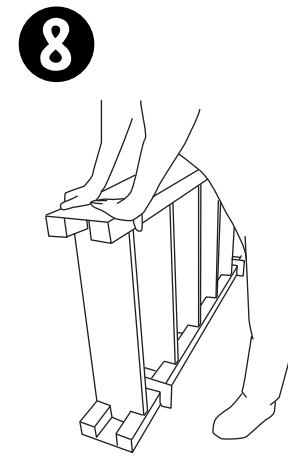
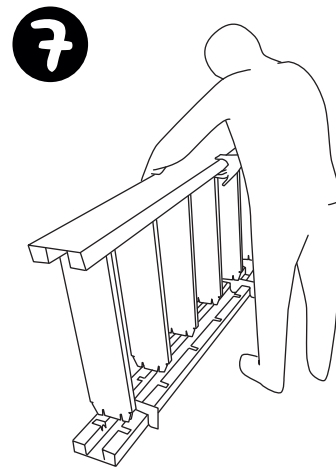
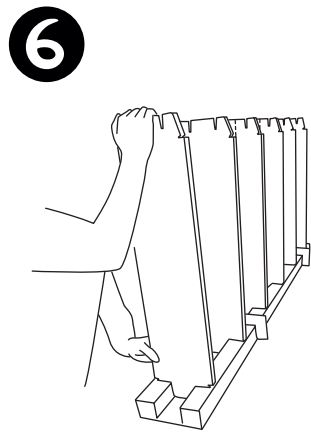
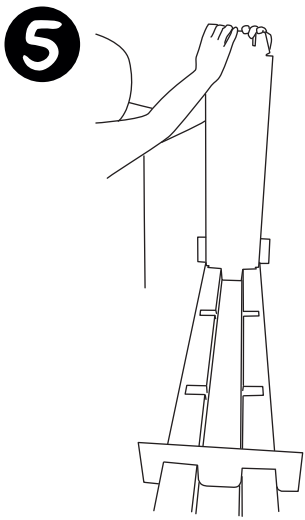

Mit der flachen Hand
alles leicht festklopfen

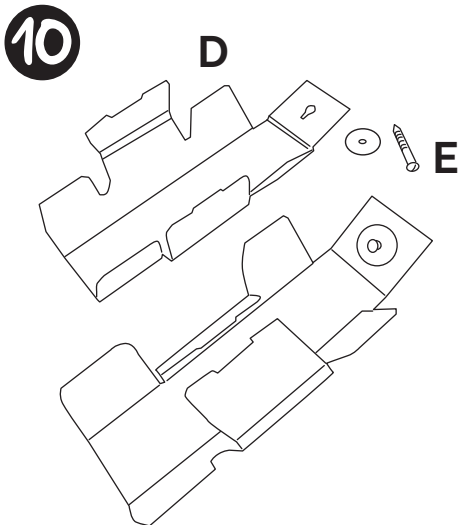
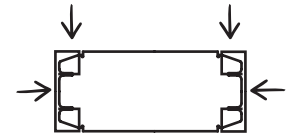
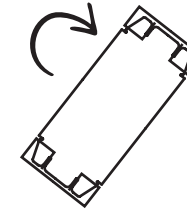
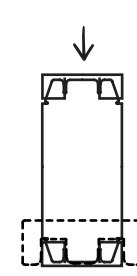
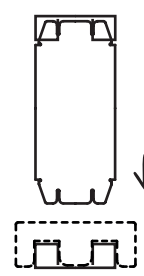
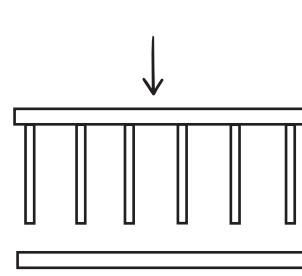
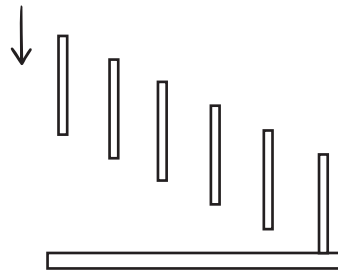
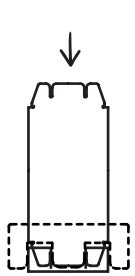

Die Wandhalterung an der
Wand anbringen (Unterleg-
scheibe verhindert das Aus-
reißen der Pappe).

Das Regal an die Wandhalterung heranrücken und
die Laschen in die Hohlräume der Seitenwand ein-
stecken.

