

Regal HUGO

Art. 8701

Stückliste:

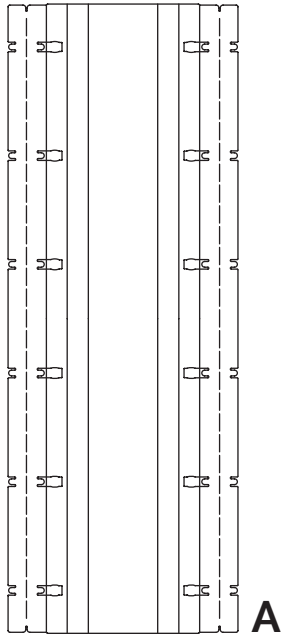

2 Seitenwände **A**



2 Aufbauhilfen **B**



6 x Regalböden **C**

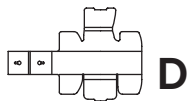

2 Wandhalterungen **D**



2 Schraubensätze **E**



Innen- und Außenseite

Bitte achten Sie beim Aufbau auf die Innen- und Außenseite. Die Innenseite hat immer einzelne, starke Rill-Linien, die Außenseite zwei schwächere.

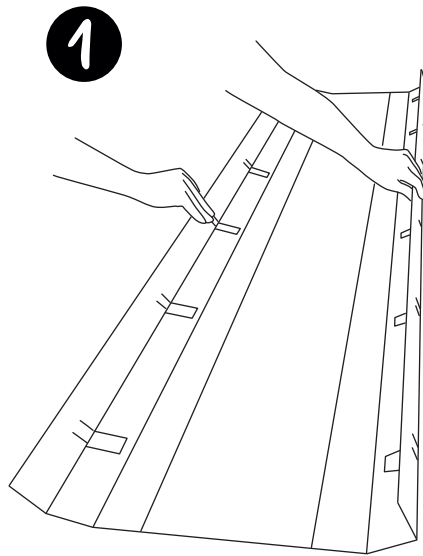

1

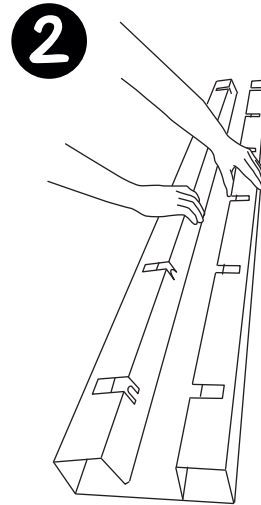

2

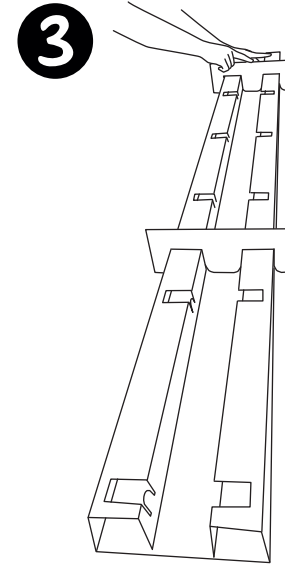

3

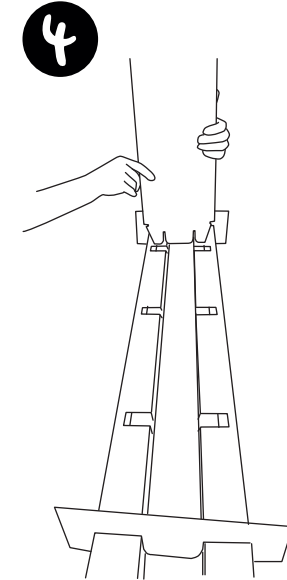

4

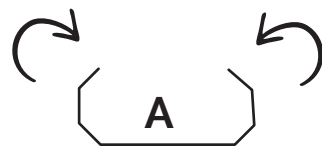
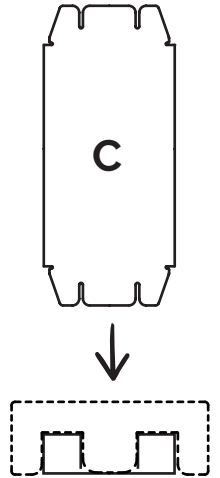

A

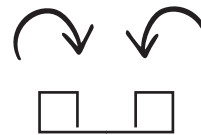

A

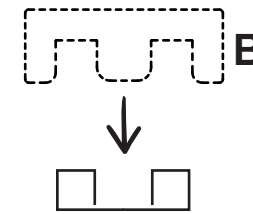

B

Die Aufbauhilfen **B** dienen dazu, die Seiten zusammenzuhalten - sie können nach dem Aufbau wieder entfernt werden.

VIDEO!

Ein Video zum Aufbau finden Sie auf YouTube:



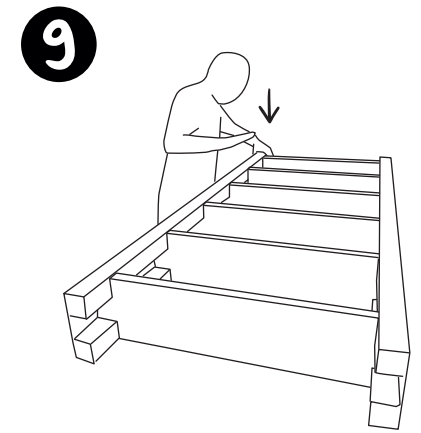
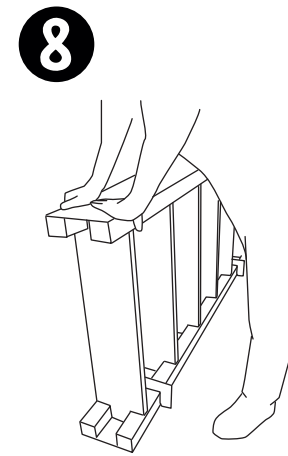
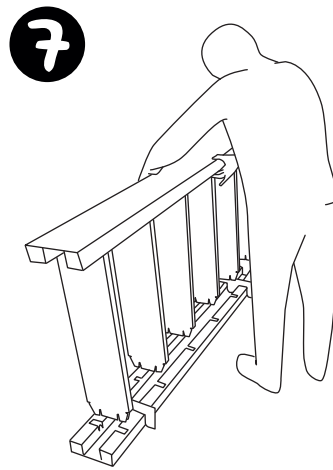
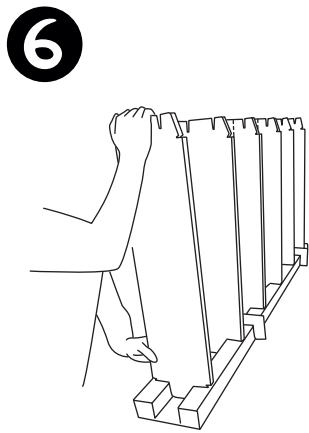
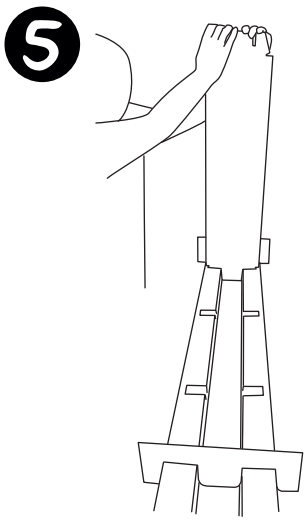

Mit der flachen Hand
alles leicht festklopfen

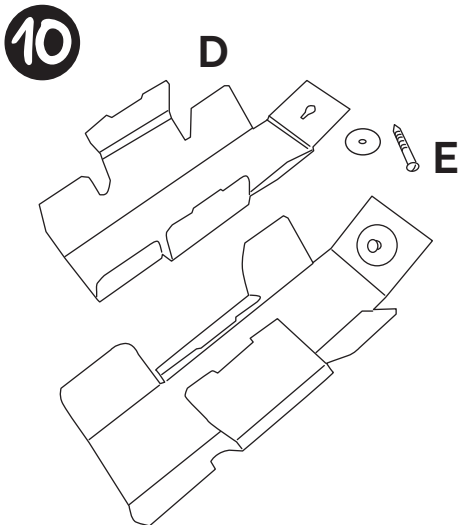
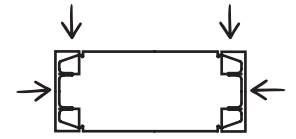
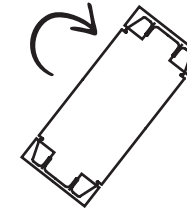
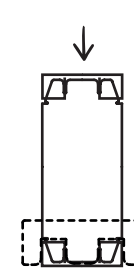
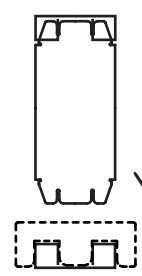
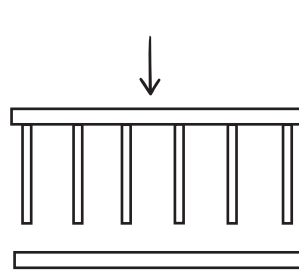
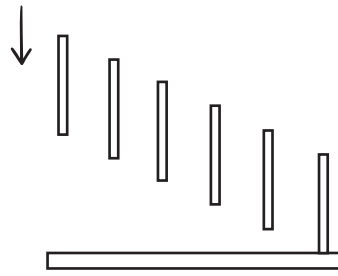
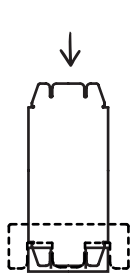

Die Wandhalterung an der
Wand anbringen (Unterleg-
scheibe verhindert das Aus-
reißen der Pappe).

Das Regal an die Wandhalterung heranrücken und
die Laschen in die Hohlräume der Seitenwand ein-
stecken.

